



GRAND RAPIDS, MICHIGAN, U.S.A. 49504-5298

**USERS OPERATING AND INSTRUCTION MANUAL**

**MODEL 690-C2**

STEAM CONVECTION  
OVEN

**INDEX**

<u>Section Description</u>	<u>Section Number</u>
SAFETY INSTRUCTIONS.....	0690S20202
DESCRIPTION/SPECIFICATIONS.....	0690S20203
INSTALLATION INSTRUCTIONS.....	0690S20204
OPERATION INSTRUCTIONS.....	0690S20205
PROGRAMMING.....	0690S20206
MAINTENANCE.....	0690S20207
TROUBLESHOOTING.....	0690S20208
RECOMMENDED SPARE PARTS LIST.....	0690S20209
PARTS LIST.....	0690S20210
HOUSING/CHAMBER ASSEMBLY.....	0690S20211
WATER ASSEMBLY DRAWING.....	0690S20212
DAMPER CONTROL ASSEMBLY.....	0690S20213
ELECTRICAL SUB-PANEL.....	0690S20214
ELECTRICAL FRONT PANEL.....	0690S20215
DOOR ASSEMBLY.....	0690S20218
WIRING DIAGRAM (208/240VAC).....	0690S20219
WIRING DIAGRAM (375/480VAC).....	0690S20220
RETURN PARTS POLICY.....	GEN860501
WARRANTY.....	GEN890601-1

**SAFETY INSTRUCTIONS**

**WARNING**

**VARIOUS SAFETY DEVICES AND METHODS OF GUARDING HAVE BEEN PROVIDED ON THIS OVEN. IT IS ESSENTIAL HOWEVER THAT THE OVEN OPERATORS AND MAINTENANCE PERSONNEL OBSERVE THE FOLLOWING SAFETY PRECAUTIONS. IMPROPER INSTALLATION, MAINTENANCE, OR OPERATION COULD CAUSE SERIOUS INJURY OR DEATH.**

1. Read this manual before attempting to operate your oven. Never allow an untrained person to operate or service this machine.
2. This oven must only be installed by qualified personnel. It also must be installed to the specifications of local plumbing and electrical codes. See the installation section of this manual for additional requirements.
3. Connect the oven to a properly grounded electrical supply that matches the requirements shown on the electrical specification plate and follow specifications of local electrical codes.
4. Disconnect and lock-out the oven from the power supply before cleaning or servicing.
5. Check and secure all guards before starting the oven.
6. Observe all caution and warning labels affixed to the oven.
7. Use only proper replacement parts.
8. Wear proper personal protective safety equipment.
9. Keep Hands away from the moving parts of this oven while it is in operation.
10. In addition to these general safety instructions, also follow the more specific safety instructions given for the different areas of the oven in the operating instructions.

**WARNING**

**DO NOT USE FOR OTHER THAN ORIGINALLY INTENDED PURPOSE.**

## DESCRIPTION/SPECIFICATIONS

### Description

The Oven is a stainless steel, electric, forced air, (convection), oven with steam injection capabilities. This oven offers consistent baking at all rack levels due to the careful positioning of the heating and air circulation systems.

In addition to the above, this oven also offers many other features. It is well insulated with a high quality asbestos free insulation. It is compact, attractive, quiet, and is easily maintained. Should electrical servicing ever be required the electrical components are readily accessible by removing the side or back panels.

The lighted, tempered glass door with its high temperature seal allows a full view of the trays in the oven during baking.

The oven computer allows you to bake two items at once which makes the oven more productive. It also has one of the fastest temperature recoveries on the market allowing the oven to be turned off during non-peak hours, thus saving energy.

The oven has many protective features such as not allowing heating of the elements when the door is open. Other features are resettable thermal overloads on the motors, a high-limit thermostat, and a magnetic circuit breaker on the control circuit.

The computer allows easy selection of baking programs. The programs combine precise control of the pre-heat temperature, baking temperature, time, pre-alarm, steam, and damper control. This allows precise baking by even inexperienced individuals.

### Physical Specifications

#### Electrical Options Available:

- 3 phase, 60 hz, 480VAC, 27 Amps.
- 3 phase, 60 hz, 208VAC, 48 Amps.
- 3 phase, 60 hz, 240VAC, 53 Amps.
- 3 phase, 50 hz, 375VAC, 22 Amps

#### Product Capacities:

The Standard oven will hold (8) 18" X 26" pastry baking trays these trays will be approximately 3-5/16 inches apart when in the oven.

6, 12 and 16 tray ovens are also available.

Space Requirements:

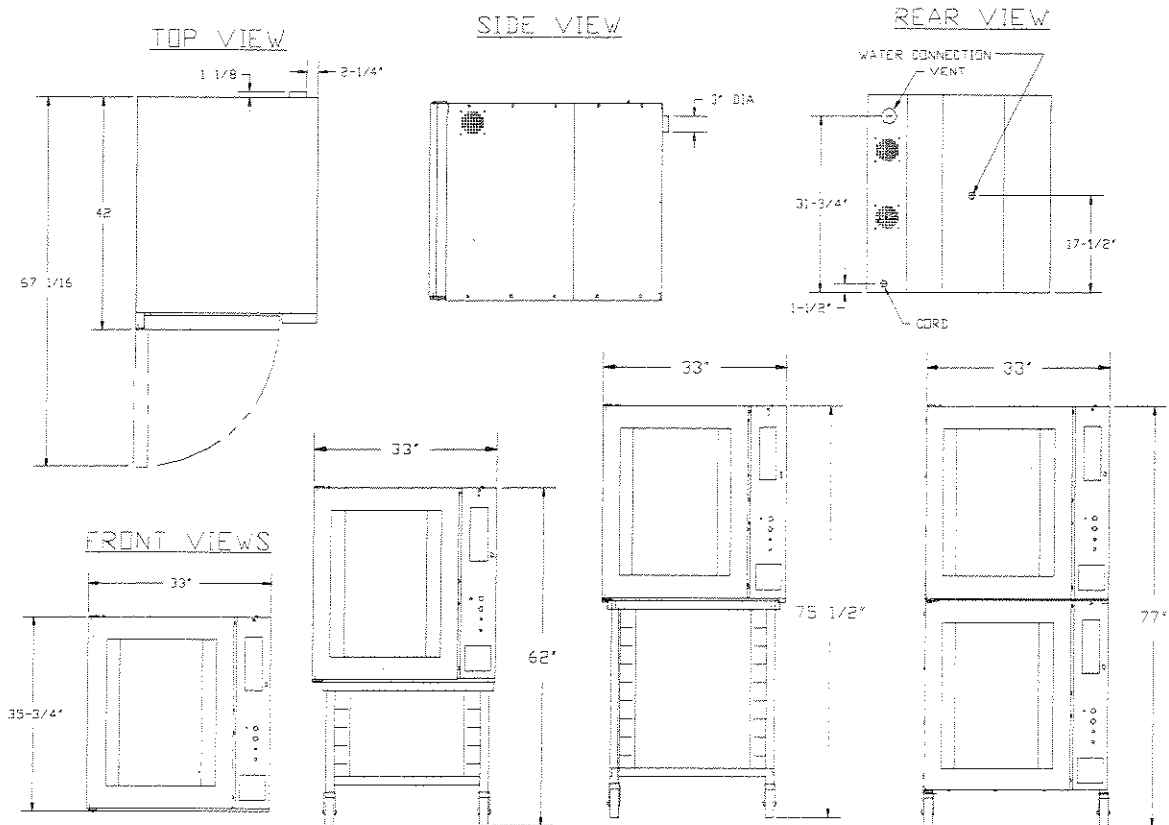

**Figure 3.0**

single: 42" Deep x 33" Wide x 35-3/4" high.  
 single with short stand and casters: 62" high.  
 single with tall stand and casters: 75-1/2"  
 stacked ovens with casters: 77"

Clearance:

Left side = 2".

Right side = 12" without casters to have access to electrical components,  
 2" with casters.

Back side = 4" to allow for water connections and venting.

Net Weight: Approximately 500 pounds.

Shipping Weight: Approximately 675 pounds.

## INSTALLATION INSTRUCTIONS

### Location Selection

Select a location where the oven will be used. It should have a grounded power supply of the same rating as that of the oven, and the power supply must be capable of carrying the load that the oven will put on it (See "Electrical Connections" below). The oven must also be placed near both a water supply and an area where the oven can be properly vented (See "Water Connections" and "Venting" below).

The oven must be set on a flat level surface. It should also be placed so that it has a minimum of two inches on the sides and a minimum of 4 inches in the rear of the oven to provide for proper venting, water, and electrical connections.

### **CAUTION**

**MAKE SURE THAT THE MOUNTING SURFACE IS ABLE TO SUPPORT THE WEIGHT OF THE OVEN WHICH IS APPROXIMATELY 500 POUNDS PLUS AN ADEQUATE SAFETY FACTOR BEFORE PLACING IT ON THE SURFACE.**

### Sealing Oven to Mounting Surface

The oven must be sealed to the mounting surface to comply with local sanitation codes. For the purpose of sealing the unit a tube of NSF/FDA approved silicone sealant has been provided with your unit. Apply, to the surface that the oven will rest on, a continuous bead of sealant approximately 1/2 inch in from each of the four sides of the oven. After the oven has been placed over this bead apply a second generous continuous bead at the joint where the oven contacts the mounting surface thus totally sealing the bottom of the oven to that surface.

### Electrical Connections

### **WARNING**

**THE OVEN MUST BE CONNECTED TO A PROPERLY GROUNDED ELECTRICAL SOURCE OF THE SAME RATING AS THE MACHINE. FAILURE COULD RESULT IN AN ELECTRICAL SHOCK WHICH MAY CAUSE INJURY OR DEATH.**

### **WARNING**

**ALL WIRING AND ELECTRICAL REPAIRS SHOULD BE DONE BY A QUALIFIED ELECTRICIAN. FAILURE TO DO SO MAY CAUSE SERIOUS INJURY OR DEATH.**

**CAUTION**

**SPECIAL HEAVY DUTY ELECTRICAL SERVICES AND WALL DISCONNECTS  
MUST BE PROVIDED FOR SAFE OPERATION OF THE OVEN.**

The following service requirements are recommended, dependent on the voltage of the unit you have purchased. For voltages other than those shown below please contact the factory.

480 Volts = 30 Amp service  
375 Volts = 30 Amp service  
240 Volts = 60 Amp service  
208 Volts = 60 Amp service

The oven is shipped from the factory with a power cord which does not include a plug. The power cord should be wired to a disconnect enclosure which is accessible from the oven work area, leave 2 feet of slack so that access can be gained to the ovens back and right side. A plug may be used between the disconnect enclosure and the oven instead of hard wiring as described above. This makes sliding the oven out to get to parts more convenient. Whatever method is used the oven should be wired in a manner which would conform to the U.S. "National Electric Code".

Check fan rotation for clockwise direction.

**CAUTION**

**FANS MUST ROTATE IN THE CLOCKWISE DIRECTION FOR PROPER AIRFLOW.  
IMPROPER DIRECTION MAY CAUSE AN UNEVEN BAKE AND A LONGER BAKE  
TIME. SWITCH TWO SUPPLY LEADS TO CHANGE FAN DIRECTION.**

Venting

On the rear side of the oven near the top is a 3" diameter exhaust vent protruding approximately 3/4" from the oven. Vent the exhaust (hot air and steam) to the outside by connecting to this vent.

**WARNING**

**HOT STEAM CAN CAUSE SEVERE BURNS AND DAMAGE TO THE SENSITIVE  
ELECTRONICS. VENT STEAM TO OUTSIDE TO AVOID INJURIES AND DAMAGE.**

Water Connections

The oven must be connected to a water supply to enable the oven to produce steam for baking. As shipped from the factory the oven will have a solenoid valve at the back center of the oven (See figure 3.0). Connect to this valve, the valve has an internal 1/4" NPT thread. Water pressure should be 60 to 70 PSI, water must also be clean. Use a pressure regulator and a water strainer/filter to meet these guidelines.

**CAUTION**

**WATER PRESSURES GREATER THEN RECOMMENDED CAN CAUSE EXCESS WATER TO ENTER THE OVEN CAUSING WATER TO LEAK AT DOOR AND TEMPERATURE TO DROP SEVERELY AFFECTING THE BAKE. USE A PRESSURE REGULATOR TO REGULATE THE PRESSURE.**

**NOTE**

**HARD WATER LEAVES MINERAL DEPOSITS ON GLASS AND OTHER SURFACES WHICH DETRACT FROM OVEN APPEARANCE.**

All water connections must comply with the basic plumbing code of the Building Officials and Code Service Sanitation Manual of the Food and Drug Administration (FDA)



**OPERATING INSTRUCTIONS**

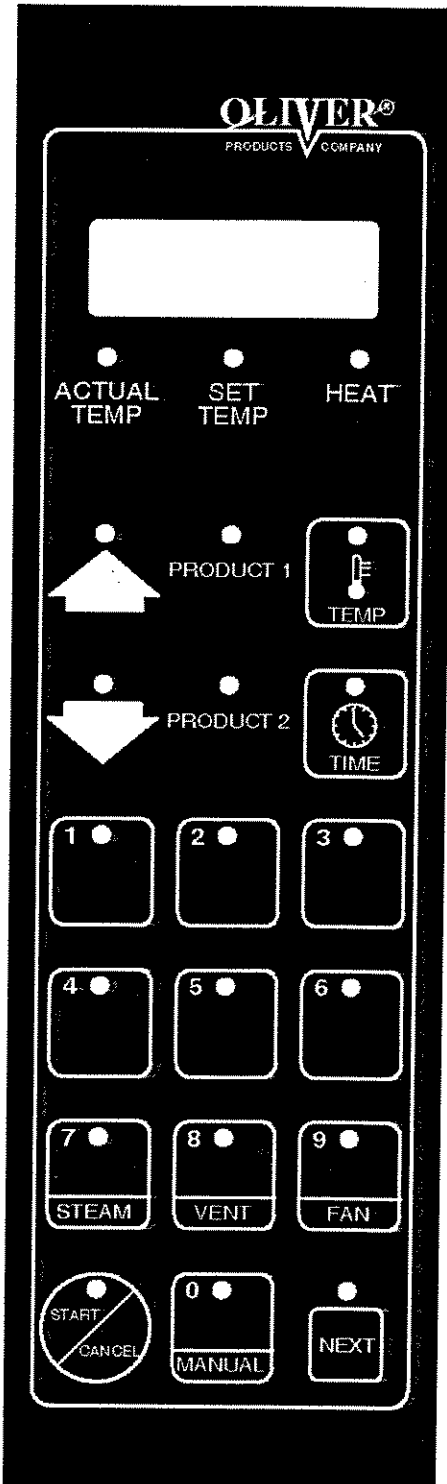



Beginning Operation

First turn the oven on by pressing the black 'Start/Reset' button below the keyboard and display. The computer will then check the oven and itself for any faults. Then the display will show the current mode which is idle **IDLE** the preset initial temperature is 250 °F.

The Keyboard and Displays

- Press the temp. key  to toggle the display between Time, Actual Temp., Set Temp, and Idle.

The display LED's will light for actual and set temperature.

- The Heat LED will light when the heating elements are on.
- Use the up and down keys   to add and subtract time in whole minute increments.

-  The time key is used when a bake is running. Press this key to display the time remaining. During 2 product baking pressing this key will briefly display the product with the most time remaining.

-  The temp key will change the display between set point, set temp, and time remaining.

-  The Start/Cancel key is pressed to start and cancel various operations.

-  The next key is used in programming.

- Other detailed key descriptions are explained in the next sections.

idle

Idle Mode

From Idle mode you can:

- Run an automatic program.
- Run a manual program.
- Adjust the temperature.
- add steam.
- open and close the vent.
- change the fan setting.

Running an Automatic Program

1. From Idle mode **idle** enter the program number (01 - 40) using the keypad
2. Wait 3 seconds or press the start key to begin preheat stage.
3. Wait for oven to reach set temperature. The display will show lo or hi and the menu number. When the set point is reached the buzzer will sound and the display will show ready **ready**.
4. Put product into the oven.
5. Close door, bake begins.
6. Pre-Alarm #1 **PRE1** will sound if programmed, press  to cancel the alarm. For more details see the Pre-Alarm section.
7. Alarm will sound when bake is finished and display will show **done**, and the program number **40**.

Open the door to end the program, this will hold the current bake temperature, add time if required by pressing the up button. **OR**



Press cancel  to end the bake and return the holding temperature to 250 °F.

Running two Automatic Programs at the Same Time

If two programs are compatible they may be run at the same time. They must both be single stage menus with identical temperatures. While the program is running (Product 1 LED will be lit) enter the second program number (01-40) and hit start. Now both product LED's will be lit, the one with the shortest time will have a flashing LED and the time remaining will be displayed. To briefly display the time of the other product press

the Time key 

Pre-Alarm

The pre-alarm will go off during the bake as programmed. The alarm will sound and the display will show  (the 1 is for product-1, product-2 pre-alarm displays ) press cancel or open the door to clear the alarm.

For advanced users: *While the pre-alarm is displayed it is possible to add time to it. Do this by pressing the up key. Press the up key once for each minute. Then wait three seconds or press the start key. Example: by adding 2 minutes to the pre-alarm, another pre-alarm will sound in two minutes. It is then possible to add time again and again.*

*If the alarm is cleared by opening the door it is still possible to add time. However if the door is then shut and the up key isn't pressed within three seconds, the pre-alarm will be cleared and it will not be possible to add time.*

Running a manual program

From idle mode  press the manual key  then press start 

Now enter the desired temperature by using the numeric keypad or the arrow keys to scroll.

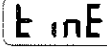
Press the next key  to advance. Display will show  which prompts you to enter the time.

Using the numeric keypad enter the time in minutes and seconds.

**Example: Run a manual program at 350 °F for 10 minutes**

Display Shows



Press Button(s)...





and



Countdown begins.

Adjusting the Temperature

The temperature can be changed while in manual or idle mode. Here is an example of how to change the temperature from 350 to 380.

Display Shows

Press Button(s)...



or

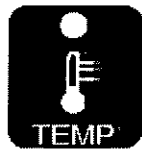

Actual temp,

Press the temp key again





Set temp.

Use  and  to scroll to 380.



Press  to go back to 'Time or Idle'.

### Adding Steam

It is possible to inject steam at any time the door is closed by pressing and holding the 7/steam button .

### Opening and Closing the Vent



It is possible to toggle the vent open and closed by pressing the 8/vent key . This will not work when a program is running. Use this feature to vent some of the steam out of the oven before opening the door. However, some hot steam will always remain.



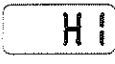

## **CAUTION**

**SUPER HEATED STEAM IS INVISIBLE AND IS POSSIBLY PRESENT IN THE OVEN. THIS STEAM MAY BURN SKIN. STAND AS FAR AS POSSIBLE AWAY FROM OVEN WHEN OPENING THE DOOR. THEN PROCEED WITH CAUTION.**

### Changing the Fan Setting

The fan cannot be changed when a program is running.

In manual mode the fans can be set to high  or low  by pressing the 9/fan key .











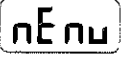

In Idle mode the fans can be set to high , low , or cool down  using the 9/fan key .

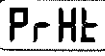
*Cool down allows the the oven chamber to quickly cool down by keeping the blowers running while the door is open.*

*The low fan setting is helpful for high sugar product.*

## PROGRAMMING

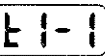
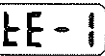
The following are instructions for editing and creating a menu program.

1. Enter the Program Mode by pressing the up and down keys   simultaneously for 5 seconds.
2. Display shows  for MENU.
3. Key in the menu number you want to program (01-40), or use the up and down keys to scroll.  
Programs 01-20 can hold two stages.  
Programs 21-40 hold one stage
4. Press the 'next' key  to edit/program the first parameter of the menu.
5. Display will show  for Pre-Heat. Use the up and down keys or the keypad to enter the preheat temperature. Press the next key  to advance.
6. Display will show  for Temperature Compensation. Use the up and down keys   to adjust temperature Compensation to on or off. Press the next key  to advance.
7. Display will show  for steam. Use the up and down keys to adjust the steam time between 0-30, C2, C3, and C4. C2 produces two cycles of 15 second steam. C3 produces three cycles etc. Press 'next' key to advance.
8. Display will show  for stage 1 time. Use up and down keys or keypad to enter the time in minutes and seconds. Press 'next' key to advance.  
Example: Enter 1200 for twelve minutes and zero seconds.
9. Display will show  for stage 1 Temperature. Use up and down keys or keypad to enter the Temperature between 250°F and 500°F. Press the 'next' key to advance.
10. Display will show  for stage 1 fan. Use up and down keys to scroll between Hi and Lo fans. Press 'next' key to advance.

11. Display will show **E 1-2** for **stage 2 time**. Stage 2 only works for menus 01-20 (For menus 21-40 skip to the Pre-alarm). Use up and down keys or keypad to enter the time in whole minutes. Entering 0 will eliminate stage 2 and skip you past the rest of the stage 2 parameters. Press 'next' key to advance.
  
12. Display will show **E E-2** for **stage 2 Temperature**. Use up and down keys or keypad to enter the Temperature. Press the 'next' key to advance.
  
13. Display will show **FAn** for **stage 2 fan**. Use up and down keys to scroll between Hi and Lo fans. Press 'next' key to advance. Best results are achieved with the fans on HI.
  
14. Display will show **PrE** for **Pre-Alarm**. Use the up and down keys to select the Pre-Alarm in whole minutes (0 to 30). Example: A pre alarm value of 1 will sound an alarm 1 minute before the time expires. Press 'next' key to advance.
  
15. Display will show **UEnt** for **Vent**. Use the up and down keys to scroll closed, open or 1-14 minutes. Venting example: A vent time of one minute will make the vent open one minute before the end of the menu program. Press 'next' key to complete program and return to the menu prompt.
  
16. Enter the next menu number to be programmed or press cancel to leave programming mode.

**MAINTENANCE**

**WARNING**

**NEVER ATTEMPT TO CLEAN OR SERVICE THIS OVEN UNTIL IT HAS BEEN DISCONNECTED FROM THE POWER SUPPLY AND IS COOL TO THE TOUCH.**

Cleaning

The outside of the oven should be cleaned daily by wiping it with a clean damp cloth or by using any suitable stainless steel cleaner. A solution made up of a mild detergent with water will normally be sufficient for routine cleaning of the interior of the oven. When finished dry the surfaces with a clean cloth.

The glass door should be cleaned daily using normal glass cleaners.

For more difficult cleaning jobs such as where there are burned on or greasy deposits, or heat tint, you should use an abrasive pad. Remember for best results always keep the stainless steel shiny.

To simplify major cleanings the inner liner may be removed by first removing the nozzle assembly in the back of the oven with an open end wrench, and then by removing the eight slotted head screws which secure the liner. Six of these screws are in the front of the oven while two additional screws are on the rear panel adjacent to the nozzle assembly.

The heating elements themselves normally do not require cleaning.

Lubrication

Occasionally put a few drops of oil on the pivot points of the door. No other items requires lubrication.

**CAUTION**

**NEVER LUBRICATE THE MOTORS**

Removal and Replacement Guide

Removing the Inner Liner:

- First remove the nozzle assembly in the back of the oven.



- Remove the eight slotted head screws which secure the liner. Six of these screws are in the front of the oven while two additional screws are on the rear panel adjacent to the nozzle assembly.
- The liner can now be removed from the oven.

Replacing the Fan or Fan Motor:

## **WARNING**

**NEVER ATTEMPT TO CLEAN OR SERVICE THIS OVEN UNTIL IT HAS BEEN DISCONNECTED FROM THE POWER SUPPLY AND IS COOL TO THE TOUCH.**

- First remove the inner liner as described above.
- Next, use a wrench to remove the hex head bolt in the end of the motor shaft which secures the fan.
- Loosen the two set screws in the hub of the fan.
- Always use a puller to remove the fan from the motor shaft to protect the bearings in the motor.
- Disconnect wires from motor, wiring connections are in the wiring box on the motor.
- Take off the four nuts and remove the motor.
- Re-install the fans and/or motors by reversing the disassembly procedures.

Changing a Bank of Heating Elements.

- Remove the inner liner as described above.
- Remove the fan(s) as described above.
- Remove the electrical rear side panel by removing the 9 slotted head screws which secure the cover.  
Remove the wires from the ends of the affected bank of heating elements. Make sure they are marked so that they can be returned to the new bank of elements easily.
- Remove the four hex head screws which secure the bank to the housing and remove the bank of elements.
- The interior surface where the bank of elements were previously attached should be cleaned completely of any remaining sealant.
- A new bank of elements must be sealed to the housing using a NSF/FDA approved silicone sealant.
- Finish installing the new elements by reversing the above disassembly procedures.

Replacing the Exterior Door Gasket

- Remove the 14 screws which hold the gasket retainers on.
- Remove the gasket.
- The sheet metal where the gasket was attached should be cleaned completely of any remaining sealant.
- Replace the gasket retainers but do not tighten down.
- Replace the gasket sections. Cut the gaskets so that they butt at the corners.
- Tighten the gasket retainers

- Completely seal around the base and corners of the gasket using a NSF/FDA approved silicone sealant.
- Allow sealant to dry before closing the door or operating the oven.

#### Replacing the Interior Door Gasket

- Remove the 14 screws securing the door panel (It has the exterior gasket fastened to it).
- Lay the panel down and remove the gasket from the glass and metal frame.
- Replace gasket and use a NSF/FDA approved sealant between the metal and gasket. and gasket end to end.
- Set down door frame, rounded gasket side up and run a bead of NSF/FDA approved sealant around top edge of entire gasket.
- Place glass on top of gasket. This will seal the gasket to the glass.
- Allow sealant to dry
- Replace door panel.

#### Changing an Electrical Component

### **WARNING**

**NEVER ATTEMPT TO SERVICE THIS OVEN UNTIL IT HAS BEEN DISCONNECTED FROM THE POWER SUPPLY. ALL ELECTRICAL WORK MUST BE DONE BY A QUALIFIED ELECTRICIAN.**

- Remove the front side panel which is located on the control side.
- After identifying the component which needs to be replaced remove its wires after marking them for ease of replacement.
- Remove the component.
- Re-install the component by reversing the removal procedures.

**TROUBLESHOOTING**

**WARNING**

**TROUBLE SHOOTING OF ELECTRICAL EQUIPMENT SHOULD BE PERFORMED BY QUALIFIED PERSONNEL ONLY. ELECTRICAL POTENTIAL IS GREAT ENOUGH TO CAUSE INJURY OR DEATH.**

**SOLVING PROBLEMS**

*Oven, Computer Display, And Indicator Lamps Do Not Turn On.*

- The machine is not plugged in.
- There is no power available at the outlet/disconnect
- The circuit breaker has tripped. Reset by pressing the switch so that it is flush with the front panel.
- A fuse has blown.
- The transformer has burned out.

*Oven Stops Functioning And The Fault/High Limit Lamp Turns On*

- Motor has overheated. (The blower motors are equipped with an internal thermal switch). Press reset when the motor has cooled.  
Possible causes:
  - 1.) The motor bearing has failed.
  - 2.) Something is binding the motors or blowers.
  - 3.) The rear of the oven lacks sufficient clearance to allow circulation
- Oven temperature is too high. (Your oven comes with a high temperature limit switch set at appx. 575 °F. This switch will reset when the oven has cooled.)
- A power interruption has occurred

*Oven Does Not Heat Up Or Recover From A Load Quickly*

A cooled dry empty oven can be heated from room temperature to 300 °F in four to six minutes. If the oven is not meeting this specification, then check the following.

- Check the fuses
- Check the two contactors.
- Check heater bank continuity.

Error Code Display

The error code is visible in the display. The list below outlines the standard error codes associated with this unit. They are designed to isolate specific problem areas and aid in troubleshooting your control.

<b>Problem</b>	<b>Probable Cause</b>	<b>Solution</b>
<b>Er01-</b> (ROM) Checksum error	Internal ROM is defective	Cycle Power.
<b>Er02-</b> (RAM) Checksum error	Internal RAM is defective	Cycle Power.
<b>Er05-</b> EProm Error	<ul style="list-style-type: none"> <li>• Power loss while storing data.</li> <li>• Eprom has been changed</li> </ul>	Cycle Power.
<b>Er06-</b> Zone 1/Top probe A/D underflow error	<ul style="list-style-type: none"> <li>• Incorrect sensor type</li> <li>• Measuring temperature outside the sensor range.</li> </ul>	Check sensor.
<b>Er07-</b> Zone 1/Top probe overflow error	Open sensor	Check for an open sensor.
<b>Er08-</b> Zone 2/Bottom probe A/D underflow error	<ul style="list-style-type: none"> <li>• Incorrect sensor type</li> <li>• Measuring temperature outside the sensor range.</li> </ul>	Check Sensor.
<b>Er09-</b> Zone 2/Bottom probe overflow error	Open sensor	Check for an open sensor.
<b>Er10-</b> Stack overflow error	Microprocessor error	Cycle Power.
<b>Er11-</b> Zone 1 / Top probe error	Open RTD probe	Check for an open probe.
<b>Er12-</b> Zone 1 / Top probe shorted	Probe is out of range	Check probe for short. Should be greater then 90 ohms.
<b>Er13-</b> Zone 2 / Bottom probe Open sensor	Open sensor	Check for an open probe.
<b>Er14-</b> Zone 2 / Bottom probe Shorted sensor	Probe is out of range.	Check probe for a short. Should be greater then 90 ohms.
<b>Er15-</b> Zone 1 loop error	<ul style="list-style-type: none"> <li>• Faulty heater</li> <li>• Shorted sensor</li> <li>• Bad heater contactor</li> </ul>	<ul style="list-style-type: none"> <li>• Check heater</li> <li>• Check sensor</li> <li>• Check switching device</li> </ul>
<b>Er16-</b> Zone 2 loop error	See Er15 above.	See Er15 solution above.

Advanced Functions

Checking the software version and temperatures.

Press       

Advance through the parameters by using the  key. The parameters are as follows.



Customer number should be 48.

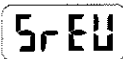

Software Revision should be 5 or higher.



Zone 1 temperature shows the temperature reading of the top probe without offset.





Zone 2 temperature shows the temperature reading of the top probe without offset.

Advanced Setup Mode

To change offset temperature or run on only 1 probe enter the following key sequence.

Advance through all parameters by using the  key. Do not change any of the parameters except the ones listed below. This is only required after a probe fails. The parameters are as follows.





Default is 2, 1 can be used when only the top probe is working.







and 

adjust with the up and down key for temperature offset for probe 1 and 2.

**RECOMMENDED SPARE PARTS**

<u>PART NUMBER</u>	<u>PART DESCRIPTION</u>	<u>NO. REQ'D</u>
5725-9620	Fuse-FRN 4 (208/240V)	2
5725-9626	Fuse-FRN 8 (208/240V)	2
5725-9634	Fuse-FRN 30 (208/240V)	6
5725-9439	Fuse-FNQR 2 (375/480V)	2
5725-9442	Fuse-FNQR 4 (375/480V)	2
5725-9066	Fuse-KTKR-15(375/480V)	6
5749-8021	Motor/Heater Contactor	3
5757-8819	Switch-Magnetic Proximity Door	1
5757-4125	Breaker-Circuit 2.5A	1
5737-2010	Lamp-Fluorescent 	1
5911-9018	Latch-Door with adjustable keeper	1
6542-0003	Glass-Door	1
6904-6062	Gasket-Door Interior	8 ft
6516-0010	Gasket-Door Exterior	10ft
5757-8083	Switch-Limit	2
6310-0003	Motor-Gear 1/110 h.p. (For Vent)	1
0690-0004	Motor-Blower (208/240/480V)	2
 0690-0004-2	Motor-Blower (375V only)	2
5712-0655	Sensor-RTD 100 Ohm	2
5712-0029	Coupling-RTD Sensor	2
5704-5011	Cable-Computer/Interface 9 Pin Mate-n-Lock	1
5704-5012	Cable-Computer/Interface 12 Pin Mate-n-Lock	1
5712-3261	Interface-Watlow Compatible	1
5712-3265	Computer-Oliver/Watlow	1
5730-2655	Heater-10KW	2
5757-9710	Switch-Thermal Surface Mount (Hi Limit)	1
6310-5027	Fan-Axial 3000 RPM (Cooling Fan)	2

**MECHANICAL PARTS LIST**

<b>ITEM NO</b>	<b>PART DESCRIPTION</b>	<b>PART NUMBER</b>
001	HOUSING-MAIN	0690-0029
002	BASE	0690-0037-1
003	WHEEL-BLOWER	0690-0045
004	SPACER-LONG MOTOR	0690-0058
005	SPACER-SHORT MOTOR	0690-0059
009	PLATE-UPPER SPLICE	0690-0063
010	PLATE-LOWER SPLICE	0690-0064
011	PLATE-SIDE SPLICE	0690-0065
013	PLATE-MOTOR BAFFLE	0690-0067-2
101	COVER-TOP	0690-0001-002
102	COVER-HINGE SIDE	0690-0002
105	COVER-ASS'Y RECESS	0690-0074
107	COVER-ELECTRICAL SIDE FRONT	0690-0039-2
108	COVER-ELECTRICAL SIDE REAR	0690-0003-201
109	PANEL-OUTSIDE REAR RIGHT	0690-0018-2
110	PANEL-OUTSIDE LEFT REAR	0690-0018-3
201	MANIFOLD-ASSEMBLED	0690-0011
205	ELBOW-STREET 3/8"NPT	5115-2211
208	VALVE-SOLENOID 2WAY	5148-6718
209	VALVE-WATER FLOWCONTROL	5148-7408
214	BUSHING-RDC'G 3/8x1/4 NPT	5115-8300
220	NIPPLE-CLOSE 3/8" X 1"	5115-8251
301	HOUSING-EMPTY	0690-0021
304	TUBE-SPACER	0690-0024
307	BRACKET-TOP DOOR HOLD	0690-0027
308	BRACKET-BOTTOM DOOR HOLD	0690-0028-1
309	SPACER-DOOR	0690-0030
310	COVER-WIRE	0690-0031
318	GLASS-DOOR 	6542-0003 
321	<del>RETAINER-TOP</del>	<del>0690-0097</del>
<del>322</del>	<del>RETAINER-BOTTOM</del>	<del>0690-0096</del>
<del>323</del>	<del>RETAINER-SIDE</del>	<del>0690-0098</del> 
324	GASKET-INTERNAL	6904-6012 
325	GASKET-EXTERNAL	6516-0010 
329	LATCH-DOOR (with adjustable keeper)	5911-9018
	LATCH-DOOR (with fixed keeper after 7/30/98)	5911-9020
330	DOOR-OUTSIDE	0690-0087-2
331	DOOR-OUTER BACK	0690-0088-2
332	DOOR-INSIDE ASSEMBLY	0690-0089-0013
333	CLIP-HORIZONTAL LAMP	5737-2911

**MECHANICAL PARTS LIST CONTINUED**

<b>ITEM NO</b>	<b>PART DESCRIPTION</b>	<b>PART NUMBER</b>
334	LAMP-FLUORESCENT 36 WATT	5737-2010
335	SOCKET-LAMP	5737-2910
336	HOUSING-LAMP	0690-0022-1
337	RETAINER-LAMP CLIP	0690-0129
401	INNER CHAMBER-8 SHELF	0690-0020
402	BAFFLE-UPPER	0690-0056
403	BAFFLE-LOWER	0690-0057
501	LEVER-LIMIT SWITCH	0690-0046
502	DISK-HEAT SINK	0690-0047
503	SPACER-HEAT SINK	0690-0048
504	PLATE-MOTOR	0690-0049
505	BRACKET-DAMPER MOTOR	0690-0050
506	CHIMNEY	0690-0051
509	COUPLING-5/16B	5604-6951
510	SWITCH-LIMIT (DAMPER)	5757-8083
511	BLOCK-TERMINAL	5770-7169
512	COLLAR-SET	5806-7053
513	MOTOR-GEAR	6310-0003
514	PLATE-DAMPER	0690-0055-1
516	BRACKET-FLAP (2 X 1/2)	0690-0101
517	FLAP-RUBBER PRES. RELIEF	0690-0102
519	SCREW-MACH #10 X 3/4	5843-5240
520	NUT-HEX MACHINE #10-24	5832-0578





**ELECTRICAL LIST**

ITEM NO	PART DESCRIPTION	PART NUMBER
007	KIT-CAPACITOR MTG.	5704-6530
018	FUSE-FNQR 4 (375/480V)	5725-9442
	FUSE-FRN 8 (208/240V)	5725-9626
019	FUSE-KTKR 15 (375/480V)	5725-9066
	FUSE-FRN 30 (208/240V)	5725-9634
020	FUSE-FNQR 2 (375/480V)	5725-9439
	FUSE-FRN 4 (208/240V)	5725-9620
021	BLOCK-FUSE CLASS CC (375/480V)	5726-1006
	BLOCK-FUSE CLASS CC (208/240V)	5726-1080
031	CAPACITOR	5704-6199
042	INTERFACE-WATLOW COMPATIBLE	5712-3261
043	TRANSFORMER-MULTI-TAPS (all models)	5760-3196
	TRANSFORMER-208/380V OVENS ONLY	5760-3195
	TRANSFORMER-240/480V OVENS ONLY	5760-3194
	RELAY-POWER 3 POLE 25A	5749-8021
044	SPACER-NYLON 1/2"	5767-5705
045	SUBPANEL-ELECTRICAL	0690-0039-2
046	BLOCK-TERMINAL 0-14 GA	5770-7463
047	BALLAST-DOOR LAMP	5702-2000
048	PANEL-ELECTRICAL BACK (375/460V)	0690-0038-101
050	PANEL-ELECTRICAL BACK (208/240V)	0690-0038-102
	FAN-AXIAL 3000RPM	6310-5027
051	PANEL-FRONT CONTROL	0690-0034-2
701	BRACKET-PROX. SWITCH	0690-0042
702	SWITCH-2 POSITION MAINTAINED KNOB	5708-6522
703	BLOCK-CONTACT 1NC	5708-6808
704	BLOCK-CONTACT 1NO	5708-6809
705	PUSHBUTTON-GREEN	5708-7806
706	PUSHBUTTON-RED	5708-7805
707	LIGHT-PILOT 1/2" SNAP-IN RED	5709-0017
708	LIGHT-PILOT 1/2" SNAP-IN GREEN	5709-0019
709	CONTROL-TEMPERATURE	5712-0015
710	COMPUTER-16 KEY	5712-3265
711	KNOB	5736-4005
712	BREAKER-CIRCUIT 2.5A MAGNETIC	5757-4125
713	SWITCH-MAGNETIC PROXIMITY DOOR	5757-8819
714	ASSEMBLY-DB-9 FOR RS 232 COM.	0690-0128
715	KIT-LOCK SCREWS	5765-7607
716	PUSHBUTTON-"STEAM"	5708-7801
717	BUZZER	5700-6051
718		



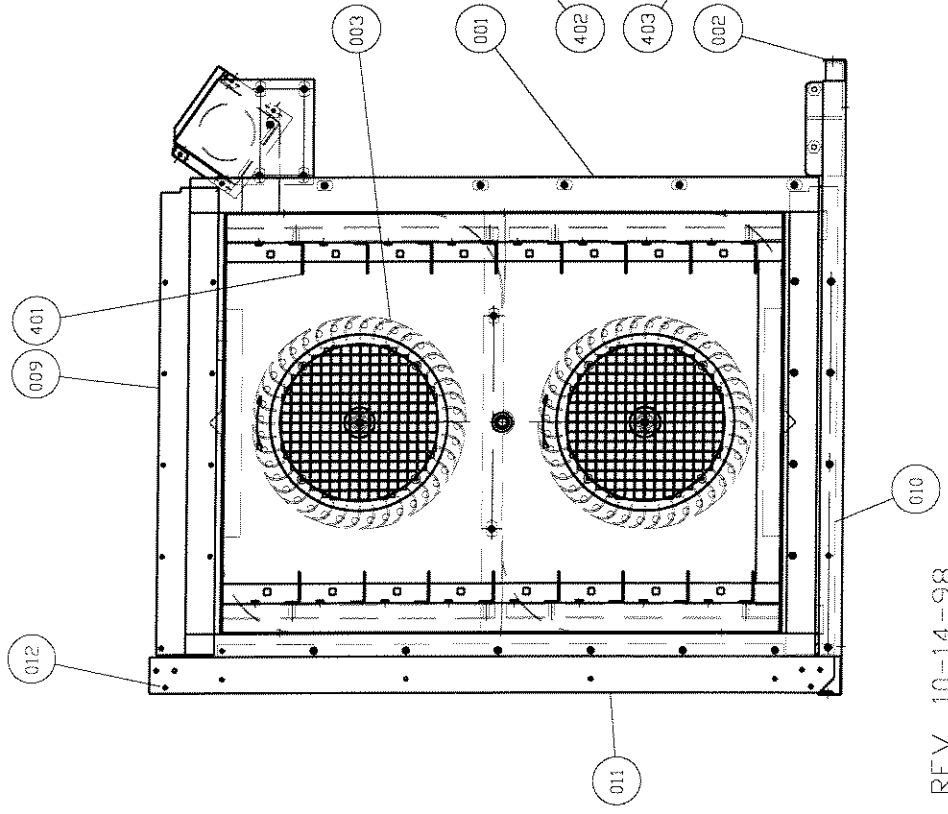
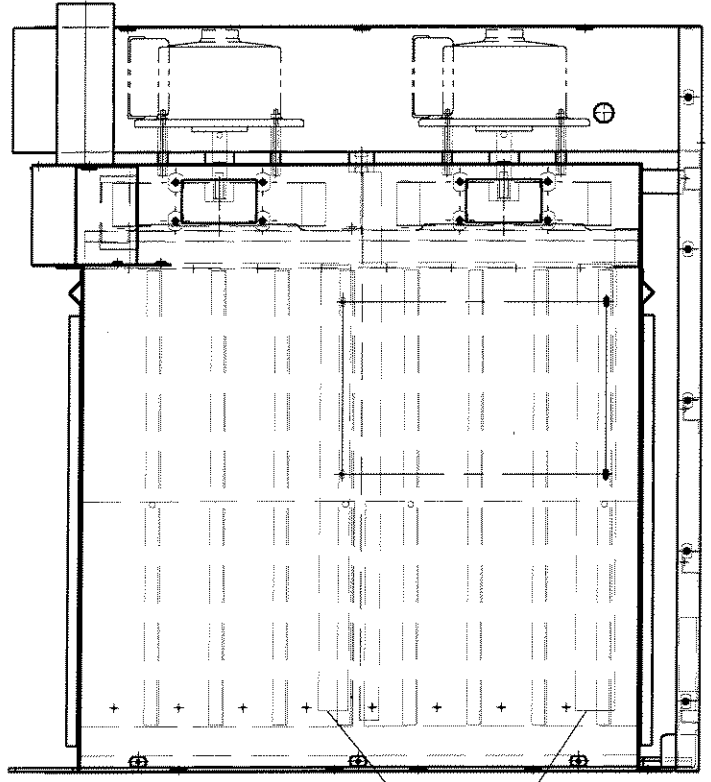
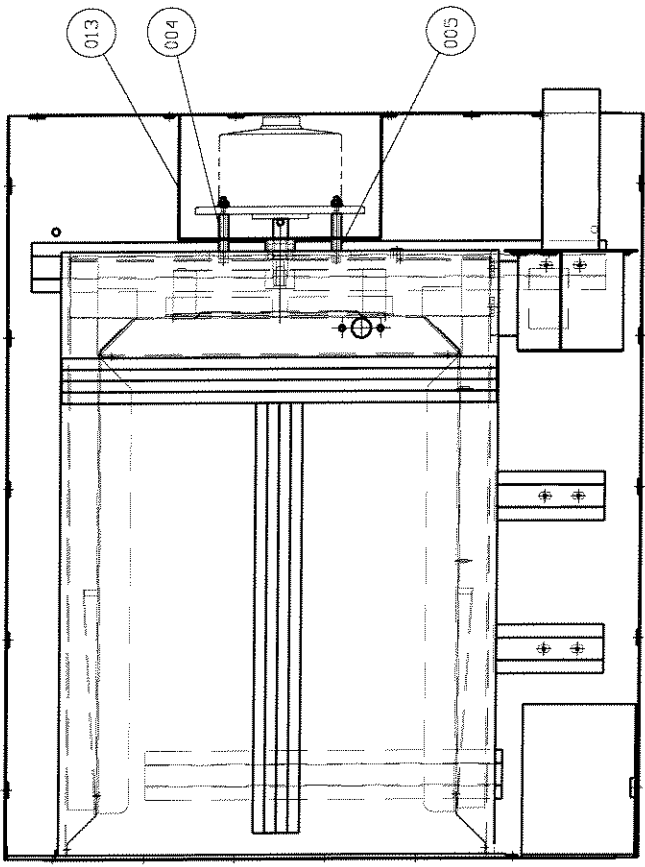

HOUSING/CHAMBER ASS'Y  
0690S20211

REV. 10-14-98

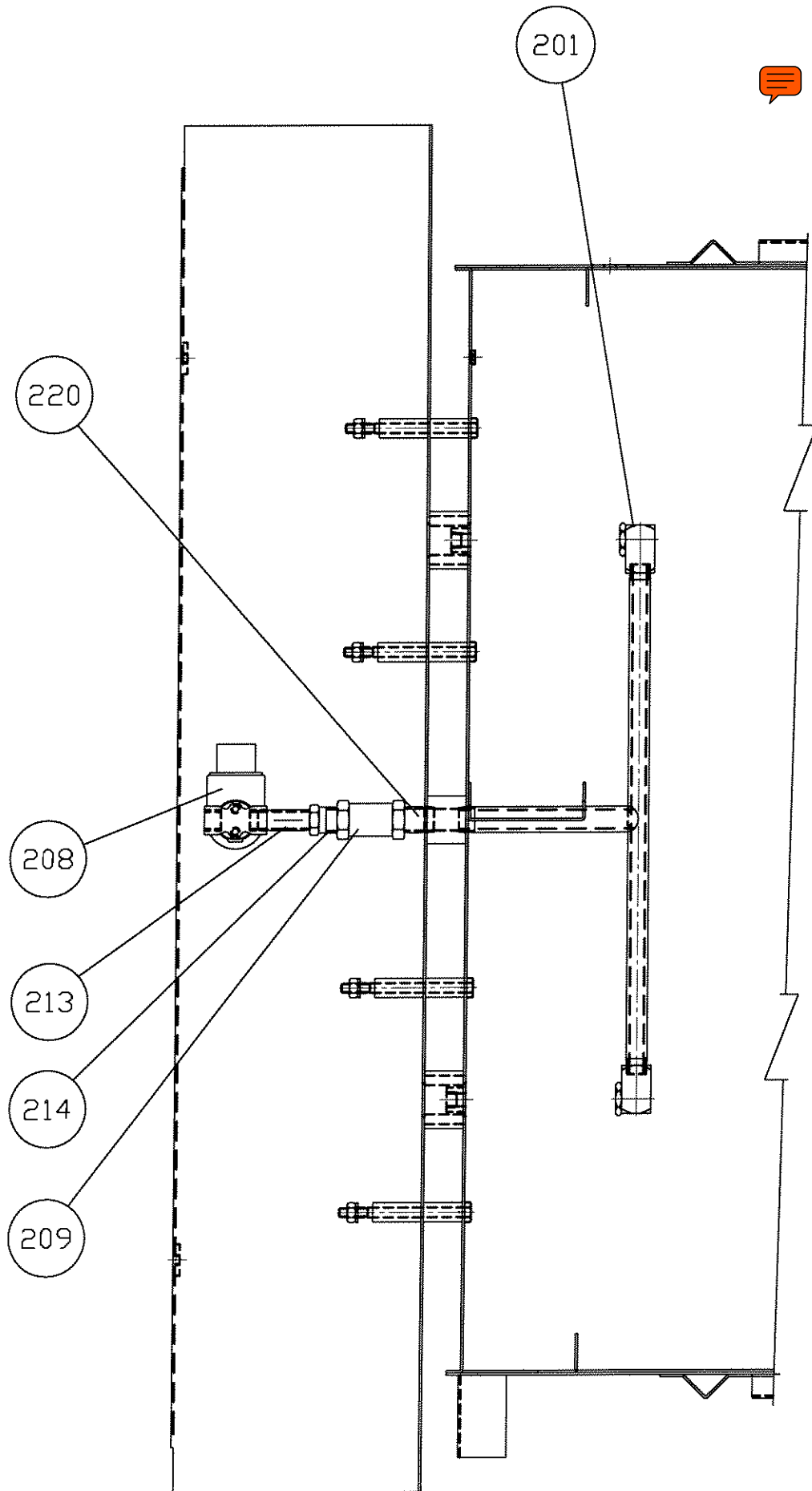

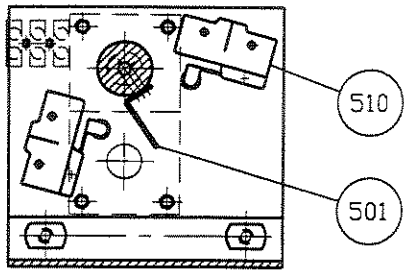

SECTION A-A

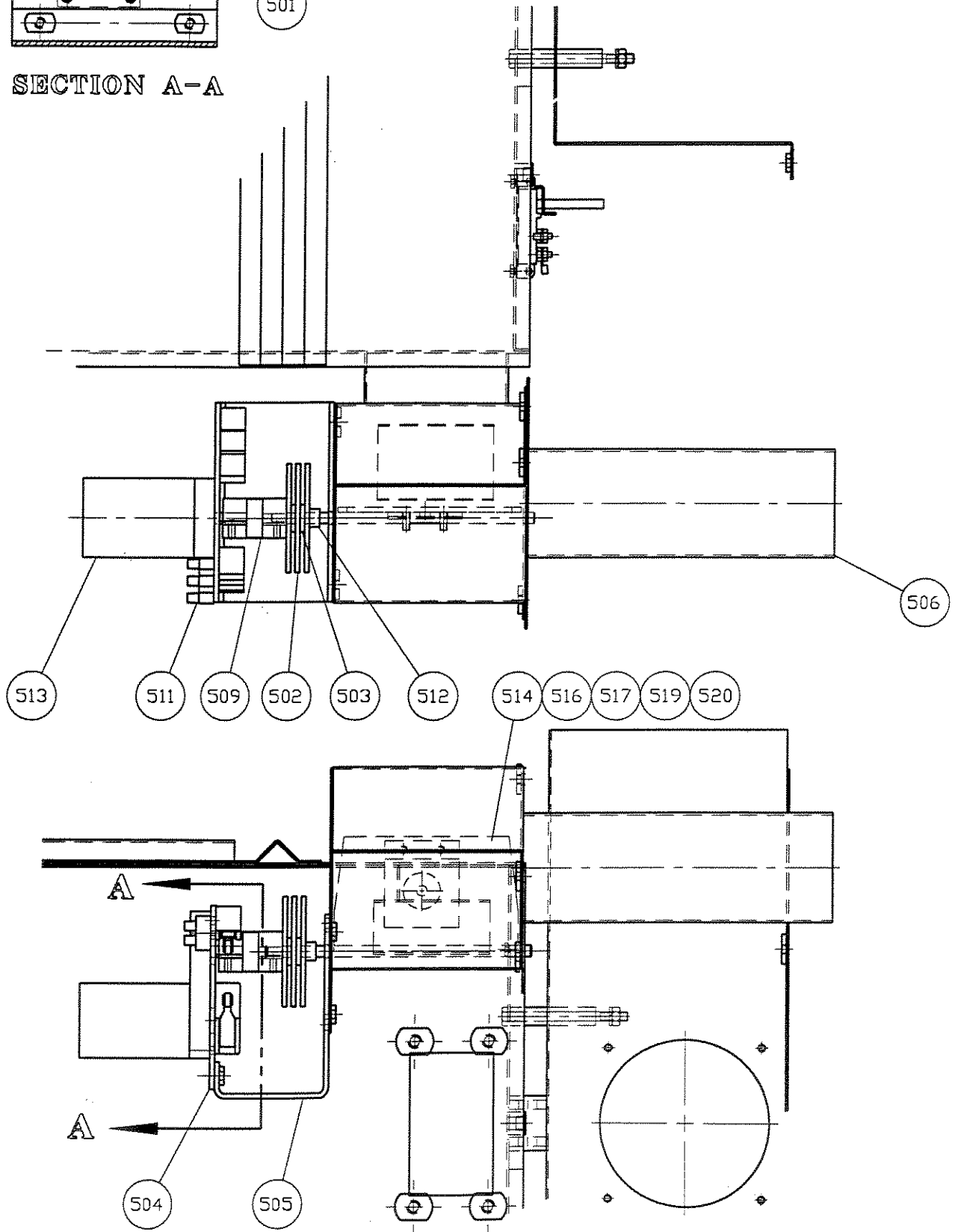

DAMPER CONTROL ASS'Y  
0690S20213

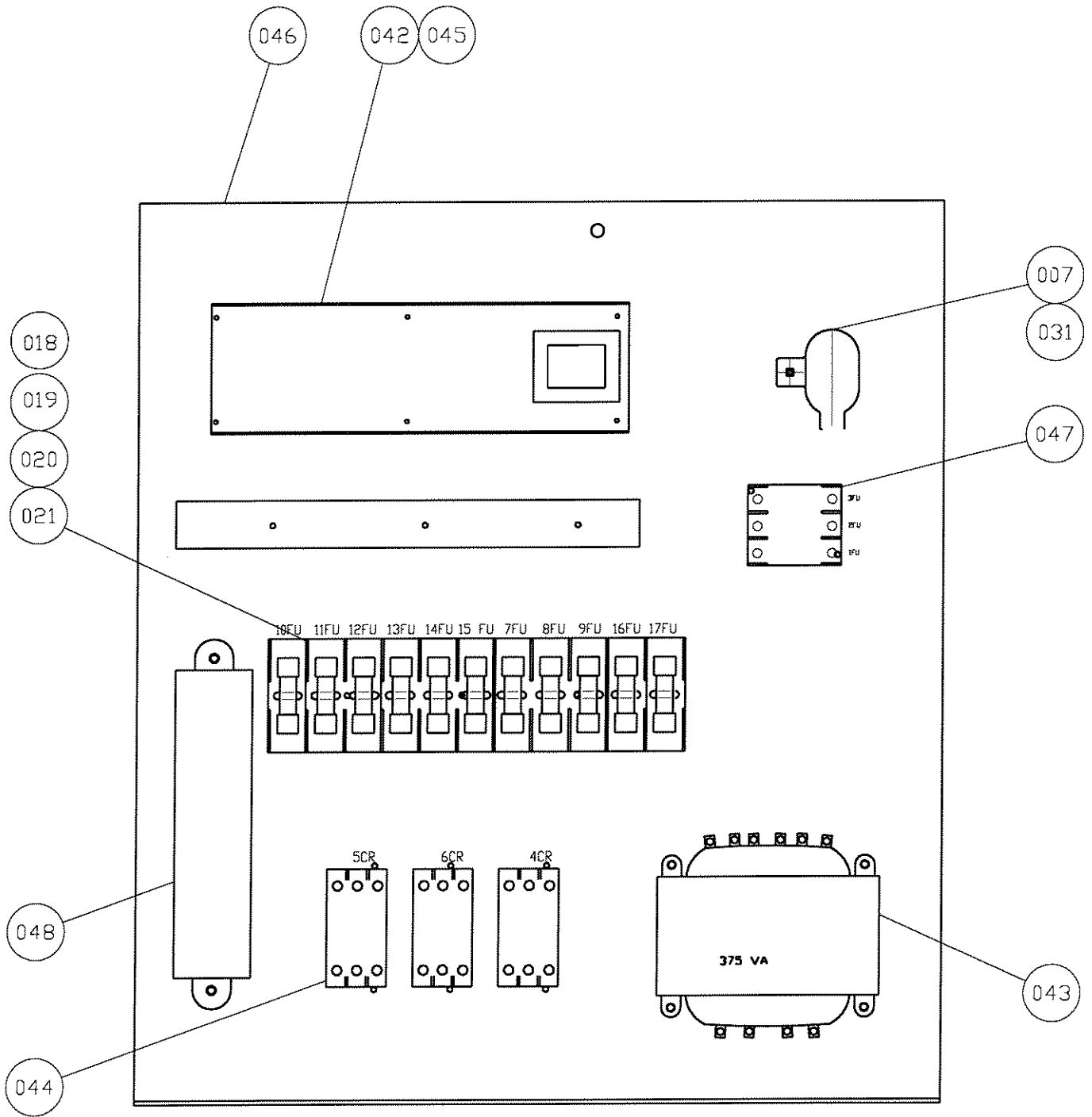

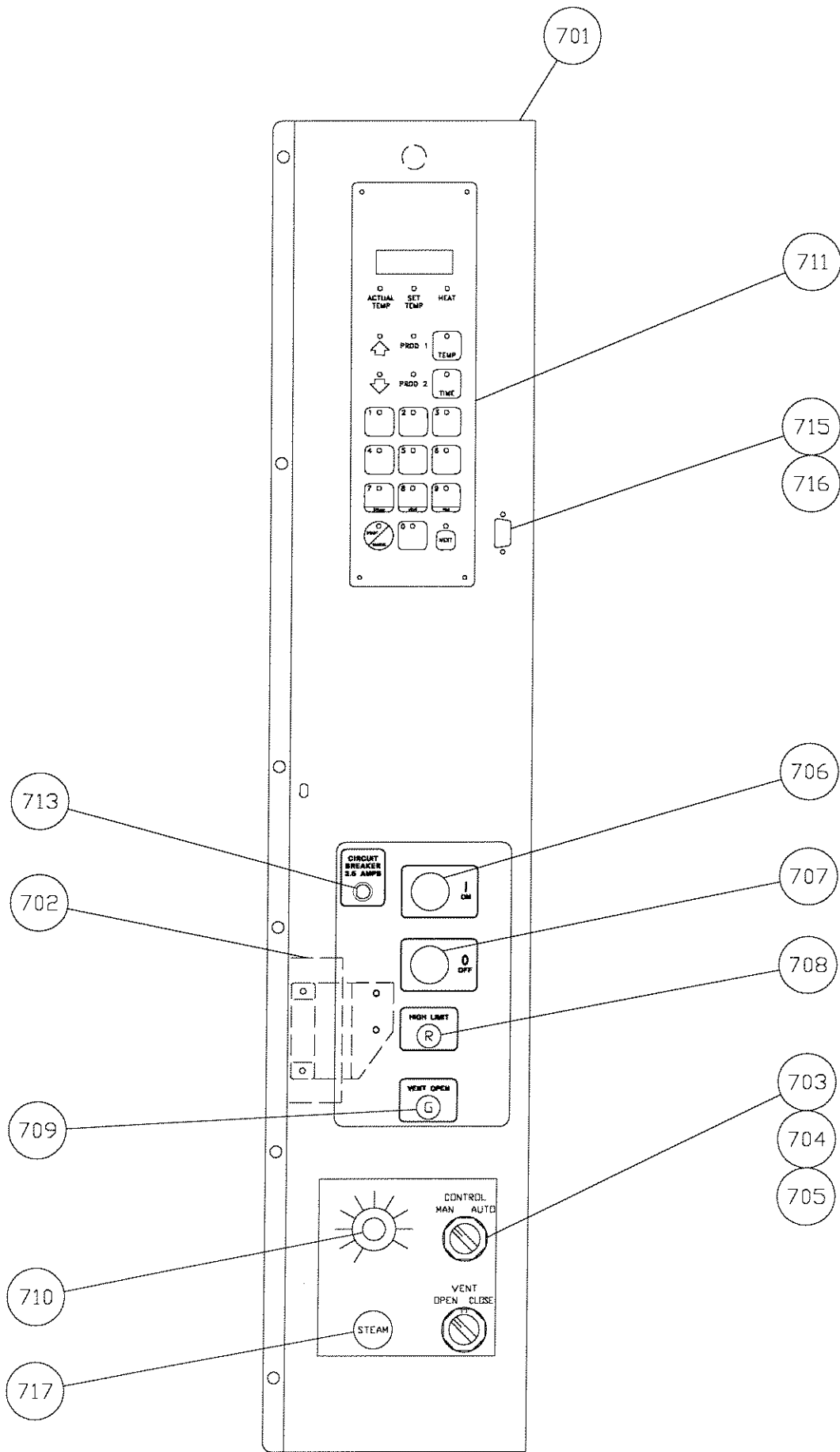

REVISED 2-19-98

FRONT PANEL  
0690S20215

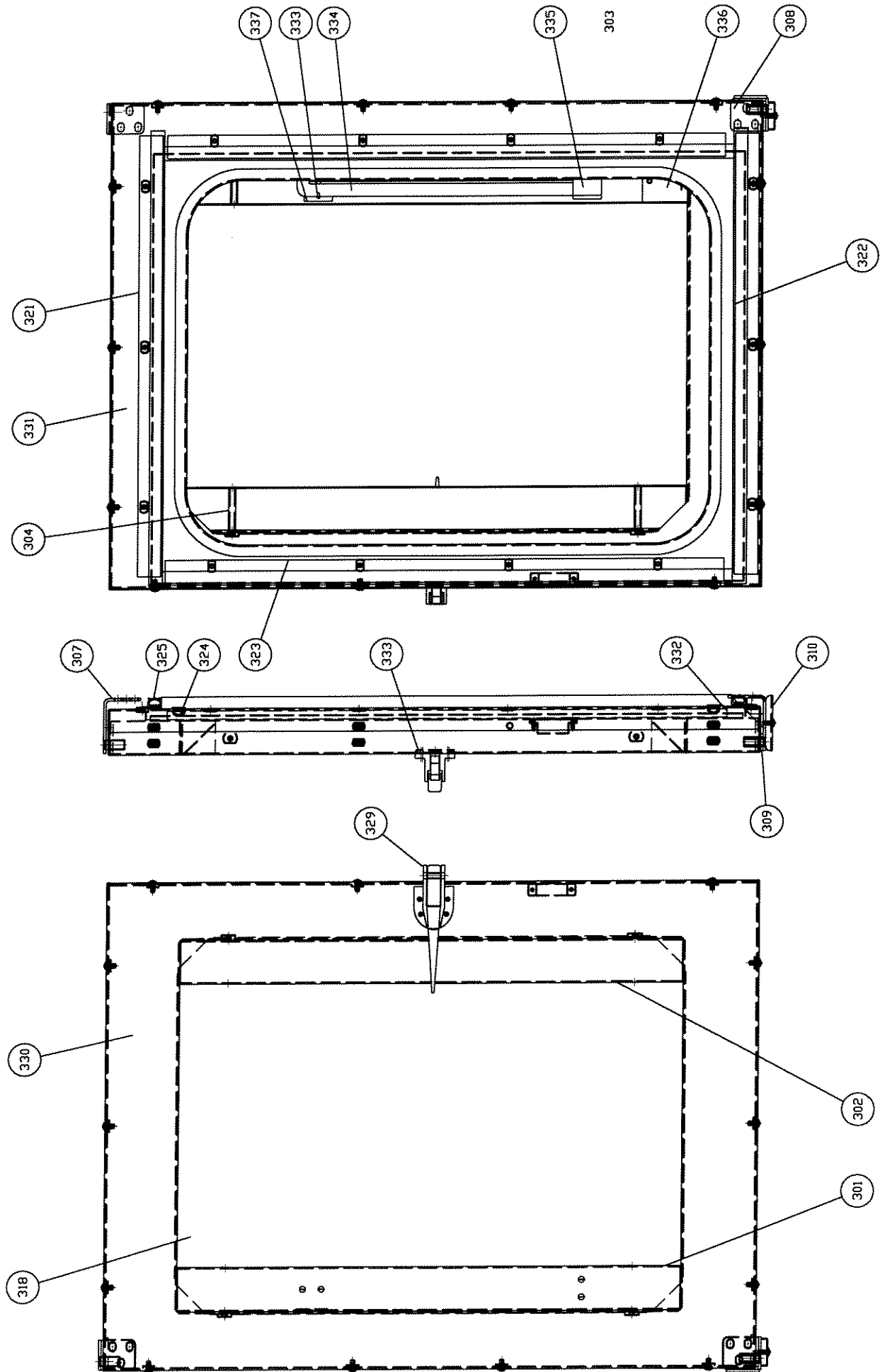

DOOR ASS'Y  
 0690S20218

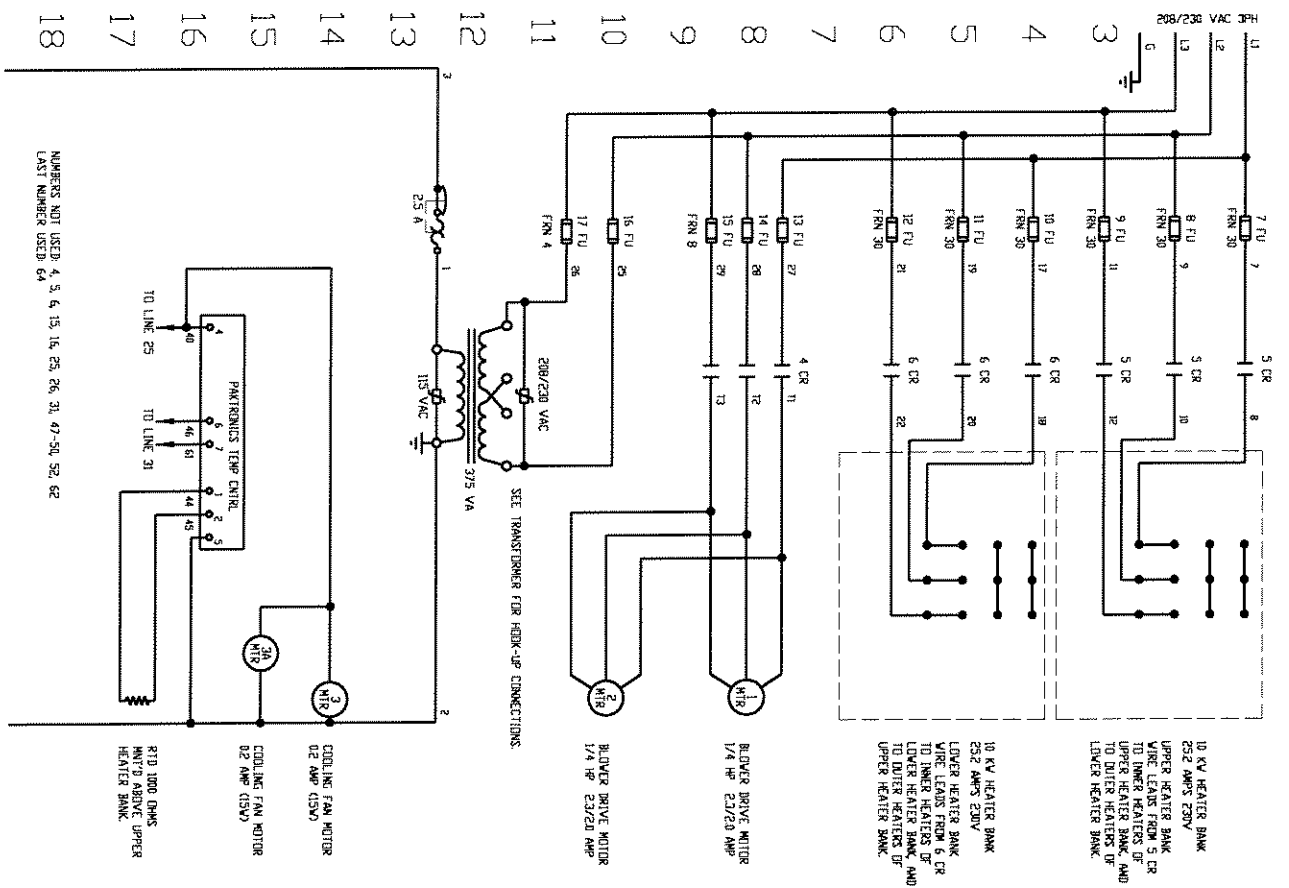

NUMBERS NOT USED: 4, 5, 6, 15, 16, 25, 26, 31, 47-50, 52, 62  
 LAST NUMBER USED: 64

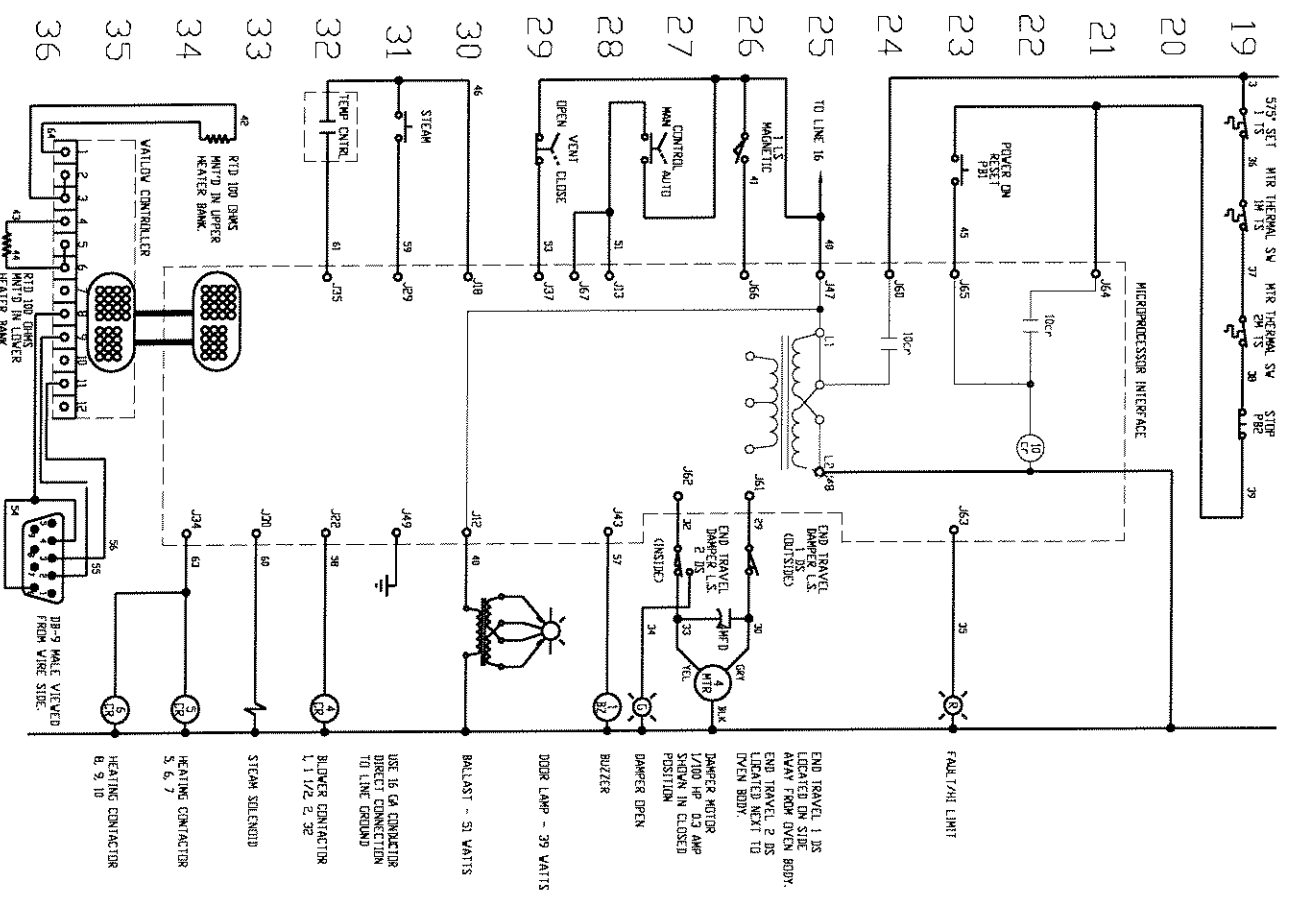

208/240V ELECTRICS  
 W/D 0690D12015  
 0690S20221



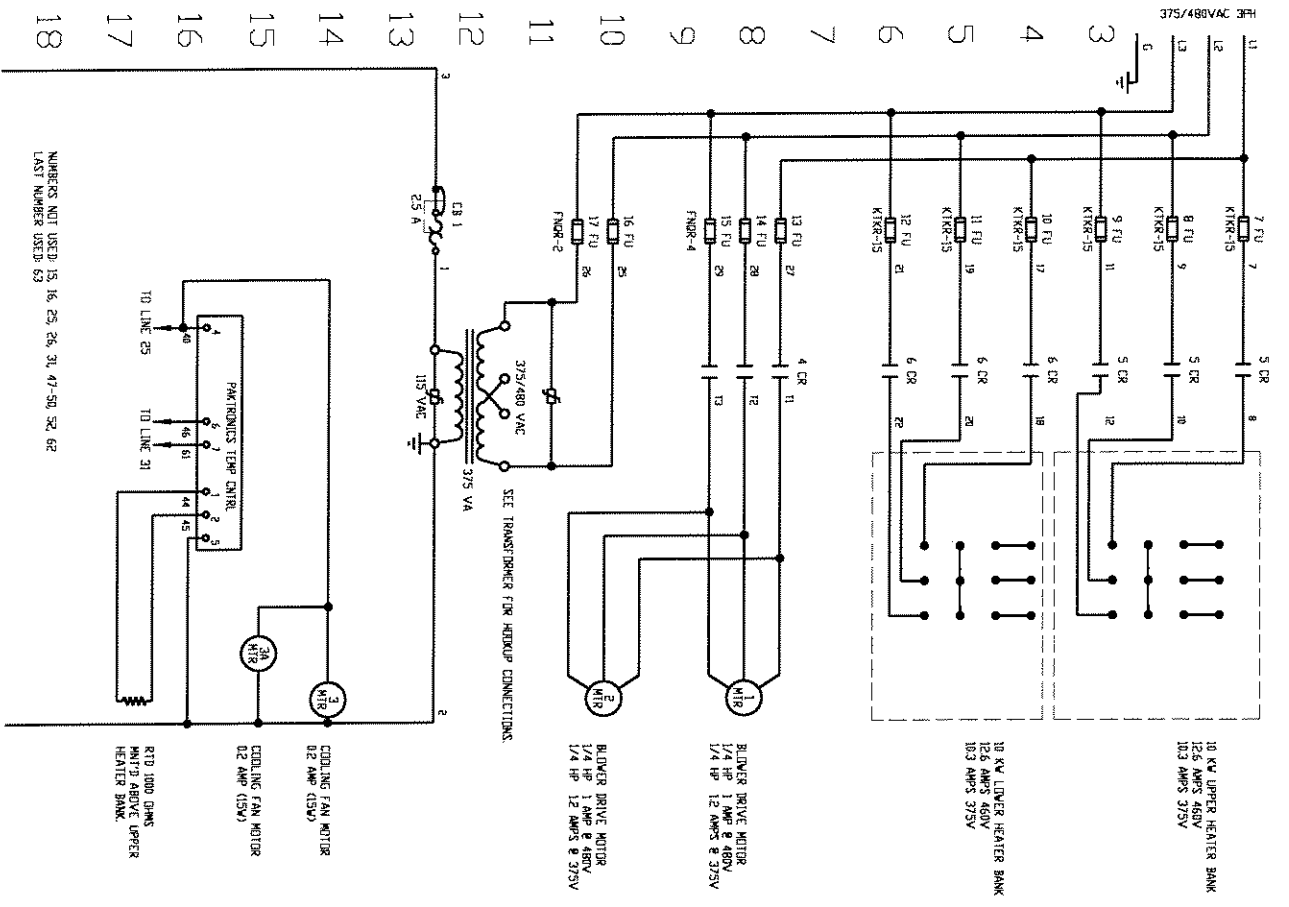

NUMBERS NOT USED: 15, 16, 23, 26, 31, 41-50, 52, 62  
LAST NUMBER USED: 63

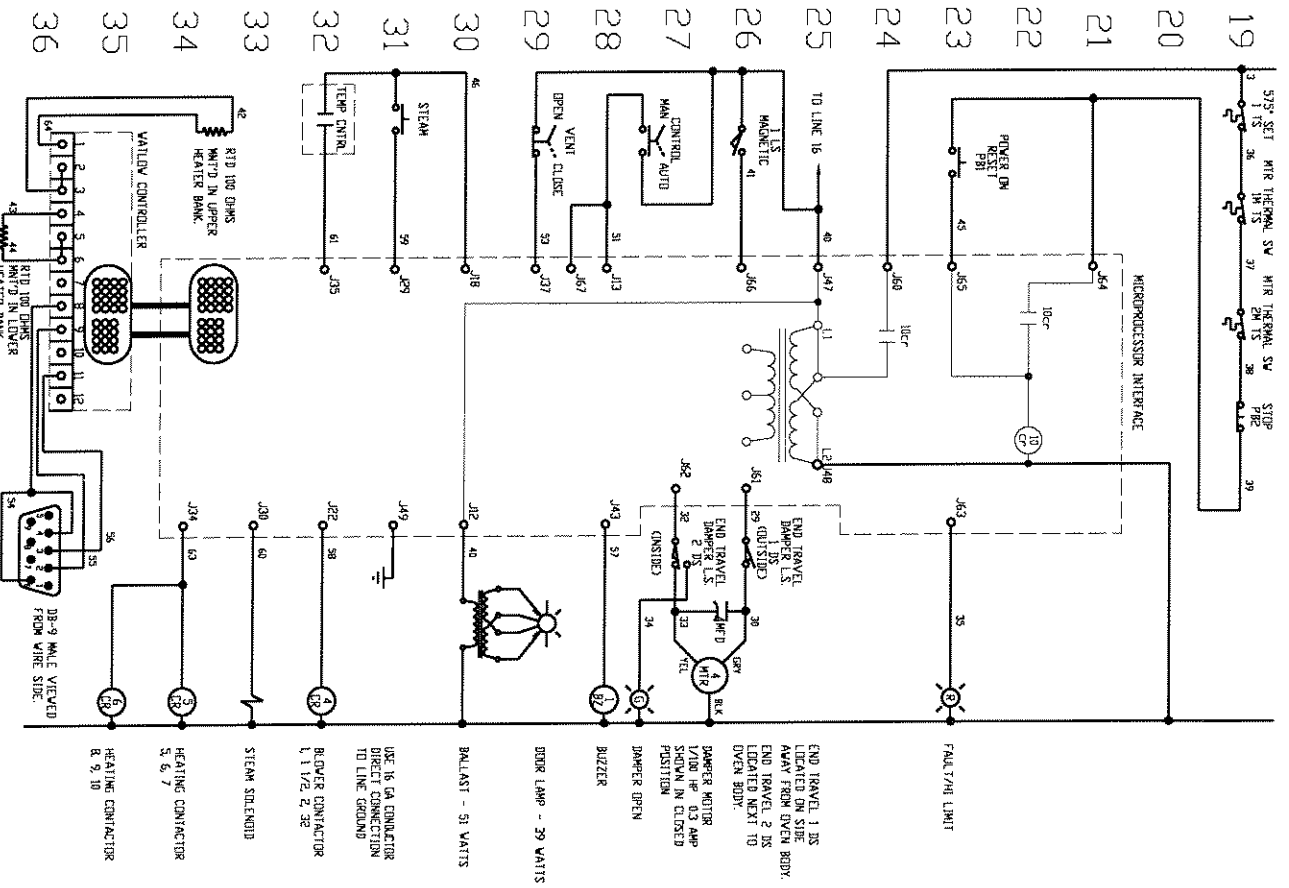

NUMBERS NOT USED: 15, 16, 23, 26, 31, 41-50, 52, 62  
LAST NUMBER USED: 63

## RETURNED PARTS POLICY

This policy applies to all parts returned to the factory whether for warranted credit, replacement, repair or re-stocking.

Oliver Products Company requires that the customer obtain a "Return Material Authorization" (RMA) number before returning any part. This number should appear on the shipping label and inside the shipping carton as well. All parts are to be returned prepaid and marked; "Attention Repair Parts Manager". Following this procedure will insure prompt handling of all returned parts.

To obtain an "RMA" number, contact the Repair Parts Dept. toll free (800) 253-3893, ext. 148 or ext. 150.

Parts returned for re-stocking are subject to a RE-STOCKING CHARGE.

Thank you for your cooperation,

Repair Parts Manager  
Oliver Products Company



445 Sixth St., N.W., Grand Rapids, Michigan 49504-5298  
(616)0456-7711 800/253-3839

---

## WARRANTY

### PARTS

Oliver Products warrants that if any part of the equipment (other than a part not manufactured by Oliver) proves to be defective (as defined below) within one year after shipment, and if Buyer returns the defective part to Oliver within one year, Freight Prepaid to Oliver's plant in Grand Rapids, MI, then Oliver, shall, at Oliver's option, either repair or replace the defective part, at Oliver's expense.

### LABOR

Oliver Products further warrants that equipment properly installed in accordance with our special instructions, which proves to be defective in material or workmanship under normal use within ninety (90) days from installation or six (6) months from actual shipment date, whichever date comes first, will be repaired by Oliver Products Company or an Oliver Authorized Service Dealer, in accordance with Oliver's published Service Schedule.

For purposes of this warranty, a defective part or defective equipment is a part or equipment which is found by Oliver to have been defective in materials workmanship, if the defect materially impairs the value of the equipment to Buyer. Oliver has no obligation as to parts or components not manufactured by Oliver, but Oliver assigns to Buyer any warranties made to Oliver by the manufacturer thereof.

This warranty **does not** apply to:

1. Damage caused by shipping or accident.
2. Damage resulting from improper installation or alteration.
3. Equipment misused, abused, altered, not maintained on a regular basis, operated carelessly, or used in abnormal conditions.
4. Equipment used in conjunction with products of other manufacturers unless such use is approved by Oliver Products in writing.
5. Periodic maintenance of equipment, including but not limited to lubrication, blade replacement, worn blades and other adjustments required due to installation, set up, or normal wear.
6. Losses or damage resulting from malfunction.

THIS WARRANTY IS NOT EFFECTIVE UNLESS THE INSTALLATION / WARRANTY REGISTRATION HAS BEEN COMPLETED, SIGNED AND RETURNED TO OLIVER PRODUCTS COMPANY WITHIN 15 DAYS FROM DATE OF INSTALLATION.

The foregoing warranty is in lieu of all other warranties expressed or implied AND OLIVER PRODUCTS MAKES NO WARRANTY OF MERCHANTABILITY OR FITNESS FOR PURPOSE REGARDING THE EQUIPMENT COVERED BY THIS WARRANTY. Oliver Products neither assumes nor authorizes any person to assume for it any other obligations or liability in connection with said equipment. OLIVER PRODUCTS SHALL NOT BE LIABLE FOR LOSS OF TIME, INCONVENIENCE, COMMERCIAL LOSS, INCIDENTAL OR CONSEQUENTIAL DAMAGES.